



CATÁLOGO 58 GENERAL

GENERAL CATALOGUE

CATALOGUE GÉNÉRAL







































desde since depuis
1955

MEDIDAS / MEASURES / MESURES

				
diámetro diameter diamètre	alto height hauteur	ancho width largeur	fondo deph height	litros liters litres

INSTALACIÓN / INSTALLATION / INSTALLATION



 madera wood bois	 fijación fixing system fixation																								
▲ abeto fir sapin * exótica sin nudos exotic whitous knots exotique sans noeuds	<table border="0"> <tr> <td>A</td> <td></td> <td>H</td> <td></td> </tr> <tr> <td>B</td> <td></td> <td>J</td> <td></td> </tr> <tr> <td>E</td> <td></td> <td>R</td> <td></td> </tr> <tr> <td>D</td> <td></td> <td>T</td> <td></td> </tr> <tr> <td>C</td> <td></td> <td>Q</td> <td></td> </tr> <tr> <td>F</td> <td></td> <td></td> <td></td> </tr> </table>	A		H		B		J		E		R		D		T		C		Q		F			
A		H																							
B		J																							
E		R																							
D		T																							
C		Q																							
F																									

 color colour couleur	 acabados finishings finitions
B blanco white blanche	ACR acero cromado chromed steel acier cromé
G gris grey gris	AL aluminio aluminium aluminium
V verde green vert	AZ acero zincado galvanised steel acier galvanisé
A amarillo yellow jaune	AZP acero zincado pintado galvanised & painted steel acier galvanisé et peint
E beig beige beige	AP acero pintado painted steel acier peint
Z azul blue bleu	AG galvanizado en caliente hot galvanizing galvanisation à chaud
N negro black noir	I acero inoxidable AISI 3004 stainless steel acier inoxydable
X gris oxiron oxiron grey gris sablé	C cartón cardboard carton
P plata silver argent	PT plástico plastic plastique
J naranja orange orange	
W múltiples colores many colours beaucoup couleurs	
R rojo red rouge	
T Transparente Transparent Transparent	

TRANSPORTE / TRANSPORT (m)

 caja box caisse	80 0,40 x 0,35 x 0,93
BUR Plástico de burbujas Bubble Wrap Plastique à bulles	120 0,50 x 0,45 x 0,95
	160 0,57 x 0,47 x 0,97
	400 0,50 x 0,28 x 1,00
	330 0,35 x 0,28 x 0,74
	960 0,50 x 0,40 x 1,40

CHAPA / PLATE / LAME (mm)

 grueso chapa thick plate épaisseur de la lame	
 diámetro perforación diameter of perforation diamètre de la perforation	
 distancia entre perforaciones distance between drilling distance entre perforation	unidades / palet units / palet unités palet

ACCESORIOS / ACCESSORIES / ACCESSOIRES

 Cerradura Lock Serrure	 Pedal Pedal Pédal	 Aro sujeta bolsas Bag ring Cercle porte-sac
--	---	---



desde · since · depuis
1955

Preselección
Preselection
Présélection4

Mobiliario urbano
Urban furniture
Mobilier urbain14

Papeleras · <i>Waste baskets</i> · Corbeilles à papier	14
Línea ARCH · <i>Line ARCH</i> · Ligne ARCH	28
Ceniceros exterior · <i>Outdoor ashtrays</i> · Cendriers extérieurs	32
Residuos caninos · <i>Dog waste</i> · Résidus canins	34
Bancos · <i>Benches</i> · Bancs	36
Aparcabicicletas · <i>Bicycle parking</i> · Parking vélos	38
Vallas, pilonas y espejos · <i>Fences, pillars and mirrors</i> · Clôtures, piliers et miroirs	39

Limpieza urbana
Urban cleaning
Propreté urbaine40

Carros · <i>Cleaning carts</i> · Chariots	40
Recogedores - escobas · <i>Dustpans - sweepers</i> · Pelles - balais	42

Soportes de saco y papeleras Bag holders and waste baskets Supports de sacs et corbeilles à papier. . . . 44

Soportes de saco · Bag holders · Supports sacs	44
Carros limpieza interior · <i>Indoor cleaning carts</i> · Chariots nettoyage intérieur	49
Papeleras y ceniceros interior · <i>Indoor waste baskets and ashtrays</i> · Corbeilles à papier et cendriers intérieurs	50

Accesorios baño Bath accessories Accessoires de bain 56

Dosificadores de jabón · <i>Soap dispenser</i> · Doseurs de savon	56
Perchas · <i>Hangers</i> · Cintres	58
Barras de ayuda · <i>Aid bars</i> · Barres d'appui	59
Portarrollos papel higiénico · <i>Toilet paper-roll holder</i> · Porte-rouleaux papier hygiénique	60
Portarrollos papel manos · <i>Hand paper-roll holder</i> · Porte-rouleaux essuie-mains	60
Secadores e insecticidas · <i>Hand dryers and insecticides</i> · Seche-mains et insecticides	62
Bobinas de papel · <i>Paper rolls</i> · Bobines de papier	63
Sacos · <i>Bags-Coats</i> · Sacs	64



*Nuevos diseños
New designs
Nouveaux dessins*

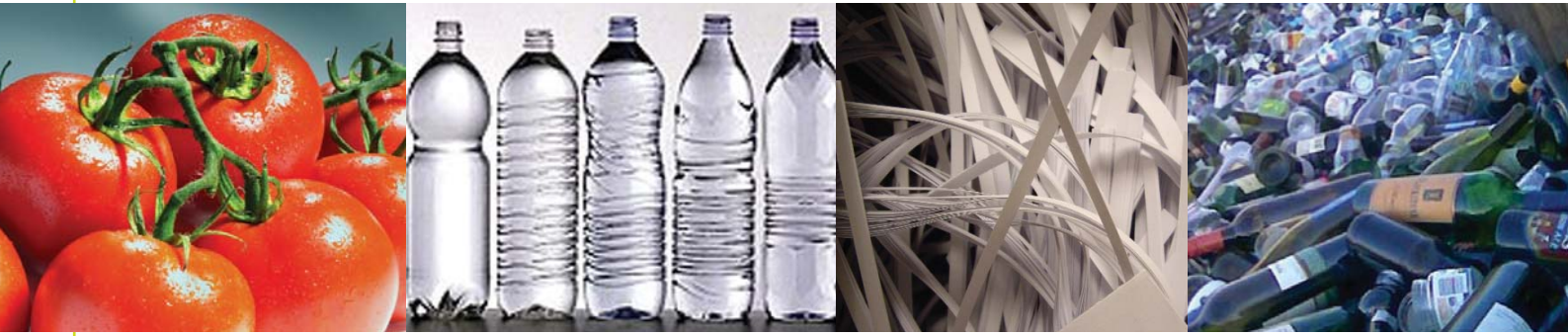

Preselección · Preselection · Présélection

Cenicero 716 y cerradura opcionales
Optional ashtray 716 and lock
Cendrier 716 et serrure optionnels



- 486 1/2
- 486 1/3
- 486 1/4



- 486-PETG 1/2
- 486-PETG 1/3
- 486-PETG 1/4



Con cerradura
With lock
Avec serrure

- 481-A 1/2
- 481-A 1/3
- 481-A 1/4





- 481-B 1/2
- 481-B 1/3
- 481-B 1/4

REF.



486	44	98		90	AZP	W	J,B	120	12
486-PETG	44	98		90	AZP	W	J,B	120	12
481-A	44	73		90	AZP	W	H,B	120	12
481-B	44	65		90	AZP	W	H,B	120	12
716	24	3,5		1	I	I			



- 481-BX 1/2 
- 481-BX 1/3 
- 481-BX 1/4 



1708 1/2 



Centenero 716 y cerradura opcionales
Optional ashtray 716 and lock
Cendrier 716 et serrure optionnels

- 486-M+716 1/2 
- 486-M+716 1/3 
- 486-M+716 1/4 

REF.	Ø	↑	↔	↘	☒	🔑	🏠	🔩	📦	↔	↻	🔗	📦	📦
481-BX	44	65			90	AZP	W	H,B		1,5	25	34	120	12
486-M	50	90			90	AZP	W	J,B	P	1,5	5	7	160	8
716	3,5	24			1	I	I							
1708	30	40			27	AZP	W							



850
1250



680-A
780-A



820





REF.	∅	↑	→	↘	☒	🔑	📏	🔩	📦	↔	↻	🔗	📦	📦	⊙
850	38	77			80	AZP	V,A,R,Z	H, B		1,5	5	260	120	15	⊙
1250	44	92			120	AZP	V,A,R,Z	H, B		1,5	5	200	160	8	⊙
680-A	38	72			80	AZP	V,A,R,Z	H, B		1,5	5	260	120	15	⊙
780-A	44	87			120	AZP	V,A,R,Z	H	▲	1,5	5	200	120	12	⊙
820		170	39,5	29,5		AZP	V,A,R,Z	E					120	15	



Centbero 716 opcional
Optional 716 ashtray
Cendrier 716 optionnel

681
781



- 484 1/2 
- 484 1/3 
- 484-M 1/3 
- 484 1/4 



Con cerradura opcional
With optional lock
Avec serrure optionnel

484

REF.	∅	↑	→	↘	📄	🔑	📏	🔩	📦	↔	↻	📦	📦	
681	38	88			80	AZP	X	H,B	1,5	5	260	120	12	⊙
781	44	104			120	AZP	X	H,B	1,5	5	200	120	12	⊙
484	44	80			90	AZP	W	H	1,5			120	12	⊙
484-M	50	80			90	AZP	W	H	1,5			160	8	⊙
716	24	3,5			1	I	I							



804
124
164



CLICK !!!



340-NA



839



120-PD



183-T
183-D

REF. Ø ↑ → ↙ ↘ 🔑 📏 🔧 📦 ⚙️ ↻ 🔄 📦 📦

REF.	Ø	↑	→	↙	↘	🔑	📏	🔧	📦	⚙️	↻	🔄	📦	📦	
804	94	37	30	80	AZP	W	B		1	25	300	80	16		⊙
124	94	42	34	120	AZP	W	B		1	25	300	120	12		⊙
164	94	49	41	160	AZP	W	B		1	25	300	160	8		⊙
120-PD	84	88	46	2-120	AP	B	R,T					120*2			⊙ ↻
183-T	82	92	39,5	3-80	AP	P	T					500			⊙
183-D	82	73	39,5	2-80	AP	P	T					500			⊙
839	85	42	35	120	AP	N	T					120	12		⊙
340-NA	62	25	18	30	AP	Z						400*2	15		⊙



REF	Ø	↑	→	↙	📄	🔧	📦	🔩	📦	↔	🔄	🔗	📦	📦
-----	---	---	---	---	---	---	---	---	---	---	---	---	---	---

362	76	36	18	40	AZP	W	H	0,8	120/2	12	🌀
462	97	42	21	60	AZP	W	H	0,8	120/2	12	🌀
369	76	36	18	50	AZP	W	H	0,8	400	15	🌀
469	97	42	21	70	AZP	W	H	0,8	400	15	🌀
218	32	27	11	10	AZP	V	Q	0,8	80/10	16	
258	50	35	19	30	AZP	V	Q	0,8	160/5	8	
801	21	37	32	80	AP	B	Q		80/6	16	🌀
121	21	42	37	120	AP	B	Q		120/6	12	🌀
121-L	100	42	34	120	AZP	W	A		120/2	24	🌀
121-LB	100	42	34	120	AZP	W	E		120/2	24	🌀
800-P	±84	37	35	80	AP	B	R,T		120	12	🌀🌀
120-P	±84	42	46	44	AP	B	R,T		160	8	🌀🌀



1160
1180
1120
1240



Aro y pedal opcionales
Optional ring and pedal
Anneau et pédale optionnels



1122

24 X 14,5 cm



156

Cartón · Cardboard · Carton



155



353



REF	Ø	↑	→	↙	📄	🔑	🧩	🔩	📦	↔	🌐	🔗	📦	📦
1160	70	44	50	60	PT	VGB	R						BUR	
1180	93	44	50	80	PT	VGMAZ	R						BUR	
1120	93	48	55	120	PT	VGMAZ	R						BUR	
1240	107	58	74	240	PT	V	R						BUR	
1122	89	55	55	120	PT	VZGAR	R						BUR	☺
155	81	41	41	120	C	B							BUR	60
156	88	42	42	120	C	B							BUR	60
353	84	44	22	30-2	AZP	N	H/Q		1,5	5	200	500	BUR	15



1121



CP060PR

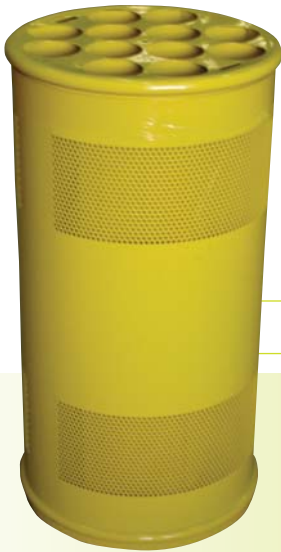

685



780-A + 015 + 020



020

REF.	Ø	↑	→	↙	☰	🔑	📦	🔩	📦	↔	↻	🔄	📦	📦
1121		87,5	51	42,5	120	PT	VZNAR	R					BUR	☰
CP060PR		60	40	31,5	60	PT	AZRN						120/5	135
685	38	72	38		80	AZP	A	H	1,5	5	260	120	12	
780-A+020+015	44	84	44		120	AZP	G	B	1,5	5	200	120	12	
020		34	8,5	15,5		I	I	Q	2,5			BUR	12	



1057



1035

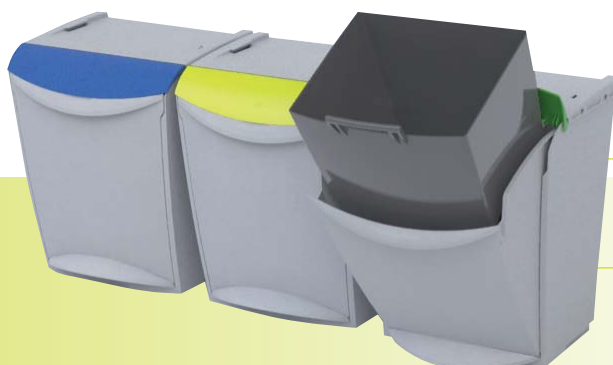

1035



1057	62,5	36	29	50	PT	BAZRV
1035	42,30	34	30	25	PT	AZGV

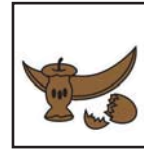
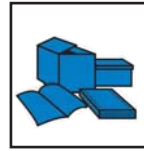

Adhesivos · Adhesives · Adhésifs
14,5 x 17 cm.



1030-30
1030-60



Con pedal
With pedal
Avec pédal



1040



REF	Ø	↑	↔	↘	📄	🔪	📦	🔩	📦	↔	↻	🔗	📦	📦
1040	36	79			40		-							
1030-30		30	41	25	30	PT	AZVRG						60	⊖
1030-60		67	50	41	60	PT	AZVRG						36	⊖



Mobiliario urbano • Urban furniture • Mobilier urbain

papeleras • waste baskets • corbeilles à papier

684 / 784

684-I / 784-I

884 / 1284



REF.	Ø	↑	→	↘	☒	☒	☒	☒	↔	↻	☒	☒	
684	38	82			41	AZP	X	J	1,5	5	110	120	15
784	44	86			64	AZP	X	J	1,5	5	110	120	15
684-I	38	82			41	I	I	J	1,2	5	260	120	15
784-I	44	86			64	I	I	J	1,2	5	200	120	15
884	41	82			41	AZP	X	J	*	1,5	5	120	15
1284	47	86			64	AZP	X	J	*	1,5	5	120	15

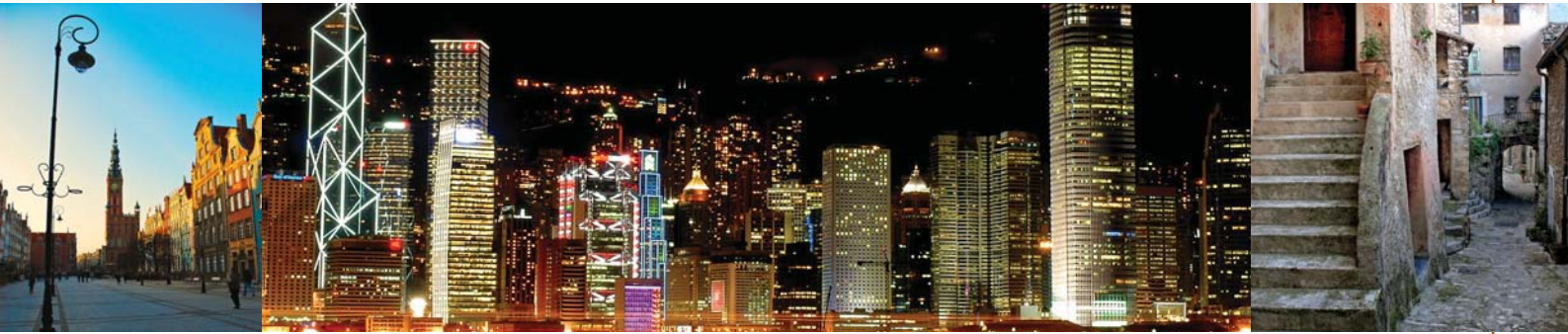

684 / 784



684 / 784



684 / 784



REF	Ø	↑	→	↙	📄	🔑	📏	🔩	📦	↔	🔄	🔧	📦	📦
684	38	79			41	AZP	X	J	1,5	5	110	120	15	🔍
784	44	86			64	AZP	X	J	1,5	5	110	120	15	🔍



Ceniceiro 716 opcional
Optibonai 716 asitray
Cendrier 716 optonmel

689
789

Cenicero 716 opcional
 Optional ashtray 716
 Cendrier 716 optionnel

689-M + 716

789-M + 716



688

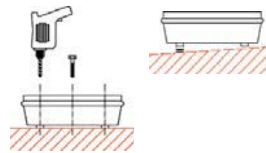

Inoxidable
 Stainless steel
 Inoxydable

Ref. 716
 Cenicero inoxidable
 Stainless steel ashtray
 Cendrier inoxydable

REF	Ø	↑	→	↘	📄	🔨	🧱	🔩	📦	↔	🔄	🔧	📦	📦
689	38	92			41	AZP	X	J		1,5	5	110	120	15
789	44	96			64	AZP	X	J		1,5	5	110	160	12
689-M	41	92			41	AZP	X	J	*	1,5	5		120	15
789-M	47	96			64	AZP	X	J	*	1,5	5		160	12
688	38	82			41	AZP	X	J		1,5	5		120	15
716	24	3,5			1	I								
Cubeta/tap/cubeau	29	61			41									
Cubeta/tap/cubeau	35	64			64									



680-A
780-A



680-AI
780-AI



680-AG
780-AG



681
781



681+716
781+716



681-I + 716
781-I + 716

REF Ø ↑ ↔ ↙ ↘ E 🔑 🏠 🔧 📦 ⇄ ↻ 🔄 📦 📦

REF	Ø	↑	↔	↙	↘	E	🔑	🏠	🔧	📦	⇄	↻	🔄	📦	📦
680-A	38	80			80	AZP	G	B,H	1,5	5	260	120	15	⊙	
780-A	44	94			120	AZP	G	B,H	1,5	5	200	160	15	⊙	
680-AI	38	80			80	I	I	B,H	1,2	5	260	120	15	⊙	
780-AI	44	94			120	I	I	B,H	1,2	5	200	160	15	⊙	
680-AG	38	80			80	AG		B,H	1,5	25	200	120	15	⊙	
780-AG	44	94			120	AG		B,H	1,5	25	200	160	15	⊙	
681	38	94			80	AZP	G	B,H	1,5	5	260	120	12	⊙	
781	44	110			120	AZP	G	B,H	1,5	5	200	160	12	⊙	
681-I	38	94			80	I	I	B,H	1,2	5	260	120	12	⊙	
781-I	44	110			120	I	I	B,H	1,2	5	200	160	12	⊙	
716	24	3,5			1	I	I								

Galvanizado en caliente

Los modelos galvanizados en caliente resisten la intemperie durante periodos muy largos. La galvanización en caliente resulta muy económica comparada con otros tratamientos y materiales.

Hot galvanizing models are outdoors fully resistant for very long periods. Hot galvanization is very cheap compared to other treatments and materials.

Les modèles galvanisés à chaud résistent aux intempéries très longtemps. La galvanisation à chaud résulte très bon marché par rapport aux autres traitements et matériaux.



850-G
1250-G



Cerradura opcional
Optional / lock
Serrure optionnel

Cubeta/tub/cubbeau ø 39 - 52 h

900



850
850-I
1250
1250-I

REF	Ø	↑	↔	↘	📄	🔑	📦	🔩	📦	↔	↔	📦	📦	📦
850	38	84			80	AZP	G	B,H	1,5	5	260	120	15	☉
1250	44	100			120	AZP	G	B,H	1,5	5	200	120	12	☉
850-I	38	84			80	I	I	B,H	1,2	5	260	120	15	☉
1250-I	44	100			120	I	I	B,H	1,2	5	200	120	12	☉
850-G	38	84			80	AG		B,H	1,5	25	260	120	15	☉
1250-G	44	100			120	AG		B,H	1,5	25	200	120	12	☉
900	52	100			65	PT / AG	G	H				160	12A	



855



780-AC



682-A



600-I



600

700



600-A

700-A

600-AI



620



REF Ø ↑ ⇄ ↙ E 🔑 🧱 🔧 📦 ⇄ ⇄ ⇄ ⇄ ⇄ ⇄ ⇄

855	38	96		80	AZP	G	B,H	1,5	5	260	120	12	⊙
780-AC	44	109		120	AZP	G	B,H	1,5	5	200	120	12	⊙
682-A	38	95		80	AZP	G	B,H	1,5	5	260	120	12	⊙
600	38	90	50	60	AZP	G	E	1,5	5	160	120	12	⊙
600-A	38	90	50	60	AZP	G	E	1,5	5	160	120	12	⊙
600-I	38	90	50	60	I	I	E	1,2	5	160	120	12	⊙
600-AI	38	90	50	60	I	I	E	1,2	5	160	120	12	⊙
700	44	90	55	70	AZP	G	E	1,5	5	160	160	8	⊙
700-A	44	90	55	70	AZP	G	E	1,5	5	160	160	8	⊙
620	38	106	50	60	AZP	G	E	1,2	5	160	120	12	⊙

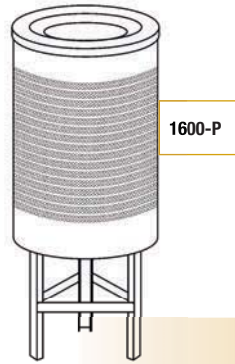

1600-P



1600



615

060 para / for / pour 600
070 para / for / pour 700



060 / 070



717-I



717

REF	Ø	↑	↔	↙	📄	🔩	📦	🔩	📦	↔	↻	🔩	📦	📦	
1600	60	108			200	AZP	G	E	2	12			120B	8	⊙
1600-P	60	138			200	AZP	G	A	2	12			120B	8	⊙
615	38	106		50	60	AZP	G	E	1,5	5	160		120	12	
060-070						AZP/I									
717	7,6	24	11		0,7	AZP	G	Q	2				BUR		
717-I	7,6	24	11		0,7	I	G	Q	2				BUR		



352	54	44	22	35	AZP	G	Q	1,5	5	160	400	18
352-I	54	44	22	35	I	I	Q	1,2	5	160	400	18
352-A	54	44	22	35	AZP	G	Q	1,5	5	160	400	18
352-AI	54	44	22	35	I	I	Q	1,2	5	160	400	18
352-AC	65	44	22	35	AZP	G	Q	1,5	5	160	400	15
352-ACI	65	44	22	35	I	I	Q	1,2	5	160	400	15
385-A	94	44	22	80	AZP	G	B,Q	1,5	5	200	400	15
385-AI	94	44	22	80	I	I	B,Q	1,7	5	200	400	15
385-AC	105	44	22	80	AZP	G	B,Q	1,5	5	200	400	15
385-ACI	105	44	22	80	I	I	B,Q	1,2	5	200	400	15



355



*i Antivandàlica, sin llave!
Anti-vandalism, no key needed!
Antivandalisme, sans clé!*



REF	Ø	↑	↔	↘	📄	🔧	📦	🔩	📦	↔	🔄	📦	📦
355	50	36	18	30	AZP	G	Q	1,5				400/2	15



356

Cenicero opcional
Optional ashtray
Cendrier optionnel



350
350-I
350-A
350-AI

Cenicero opcional
Optional ashtray
Cendrier optionnel



351
351-I
351-A
351-AI



Basculante / It swings / Bascule

174

REF	∅	↑	↔	↘	📄	🔧	📦	🔩	📦	↔	🔄	🔧	📦	📦
356	106	44	22	35	AZP	G	E	1,5	5	160	400	15	🌀	
350	90	44	22	35	AZP	X	E	1,5	5	160	400	12		
350-I	90	44	22	35	I	I	E	1,5	5	160	400	12		
350-A	90	44	22	35	AZP	X	E	1,5	5	160	400	12	🌀	
350-AI	90	44	22	35	I	I	E	1,2	5	160	400	12	🌀	
351	90	44	22	35	AZP	X	E	1,5	5	160	400	12		
351-I	90	44	22	35	I	I	E	1,2	5	160	400	12		
351-A	90	44	22	35	AZP	X	E	1,5	5	160	400	12	🌀	
351-AI	90	44	22	35	I	I	E	1,2	5	160	400	12	🌀	
804	94	37	30	80	AZP	V	B	1	25	300	80	16	🌀	
124	94	41	34	120	AZP	V	B	1	25	300	120	12	🌀	
164	94	49	41	160	AZP	V	B	1	25	300	160	8	🌀	
805	108	40	30	80	AZP	V	B	1	25	300	80	16	🌀	
125	112	44	35	120	AZP	V	B	1	25	300	120	12	🌀	
124-C	106	41	34	120	AZP	V	B	1	25	300	120	12	🌀	
124+168	94	41	34	120	AZP	V	B	1	25		120	12	🌀	
174	104	52	41	180	AZP	J	E	1	25	290	160	8	🌀	



834
1234



844
1244



884
1284



424



134



REF	Ø	↑	↔	↙	📄	🔑	🗉	🔧	📦	↔	↻	🔗	📦	📦
884	41	82			41	AZP	X	J	*	1,5	5		120	15
1284	50	86			64	AZP	X	J	*	1,5	5		120	8 ☺
834	41	73			80	AZP	M	B	▲	1,5			120	12
1234	50	91			120	AZP	M	B	▲	1,5			120	8 ☺
844	41	80			80	AZP	M	B	▲	1,5			120	12
1244	50	98			120	AZP	M	B	▲	1,5			120	8 ☺
424	50	87			70	AZP	M	H	*	1			160	8
134		90	22	34	120	AZP	M	B	▲				120	12 ☺



Cenicero 716 opcional
Optional 716 ashtray
Cendrier 716 optionnel

689-M + 716
789-M + 716



Cenicero 716 opcional
Optional 716 ashtray
Cendrier 716 optionnel

846
1246



Cenicero 716 v cerradura opcionales
Optional ashtray 716 and lock
Cendrier 716 et serrure optionnels

486-M+716 1/2

486-M+716 1/3

486-M+716 1/4



434



777



1677

REF	Ø	↑	→	↘	📄	🔑	📦	🔩	📦	↔	↻	📦	📦
689-M	41	92			41	AZP	X	J	*	1,5	5	120	12
789-M	50	96			64	AZP	X	J	*	1,5	5	120	8
846	41	94			80	AZP	M	B	▲	1,5		120	12
1246	50	110			120	AZP	M	B	▲	1,5		120	8
486-M	50	98			90	AZP	N	J	▲	1,5		160	8
434	34	95	43		50	AZP	X	A	*	1,5		80	16
777	46	55			62	AG	M	H	▲	1,5		120	18
1677	62	70			160	AG	M	H	▲	1,5		160	12



121-EXT
121-I
801-EXT
801-I

121-L

121-LB



121-EXT	21	42	37	120	AZP	B	Q	120/6	12
121-I	21	42	37	120	I	I	Q	120/5	12
801-EXT	21	37	32	80	AZP	B	Q	80/6	18
801-I	21	37	32	80	I	I	Q	80/6	18
121-L	100	42	34	120	AZP	B	A	120/3	12
121-LB	100	42	34	120	AZP	B	E	120/6	12



407

400

500



407	99	44	24	35	AZP	V	B	400	15
400	99	44	24	35	AZP	V	B	400	15
500	99	44	24	35	AZP	V	B	400	15



120-02
120-02-I



962

REF	Ø	↑	→	↘	📄	🔩	🧱	🔩	🧱	↔	↻	🔗	📦	📦	
120-02	90	45	34	120	AZP	P	E						120	12	⊙
120-02-I	90	45	34	120	I	I	E						120	12	⊙
962	130	52	40	120	AZP	G	D						120*1,5	12	⊙



451-B



451



451-A

REF	Ø	↑	→	↘	📄	🔩	🧱	🔩	🧱	↔	↻	🔗	📦	📦	
451-B	33	53	33	50	AZP	V	C			1			80	24	⊙
451	33	150	33	50	AZP	X	A			1			80	16	
451-A	33	150	33	50	AZP	X	A			1			80	16	



963-A



963-A

REF.



963-A

170

52

40

70

AZP

V

D

1,5

5

100

120*2

6





964



962



960



965



961

REF	∅	↑	→	↘	📄	🔑	🧱	🔩	📦	↔	↻	🔗	📦	📦
964	130	52	36			AZP	P	D					120*1,5	10
962	130	52	40	120		AZP	P	D					120*1,5	10 ☉
960	130	52	40	70		AZP	P	D	1,5	5	100		120*1,5	10 ☉
961	118	52	40	75		AZP	P	D	1,5	5			120*1,5	10 ☉
965	118	52	40	70		AZP	P	D	1,5	5	100		120*1,5	10 ☉



951-R



952-R



970



REF	Ø	↑	→	↙	📄	🔧	🏠	🔩	📦	↔	↻	📦	📦
951-R	60	52	5		AZP	W	A					160/5	8
952-R	90	52	80		AZP	W	E					120B	4
970	68	57	170		AZP	W	D,E	▲				BUR	



971



980



982



983

REF	Ø	↑	→	↘	📄	🔩	🧱	🔩	📦	↔	↻	🔗	📦	📦
971	78	57	170		AZP	W	D,E	▲						BUR
980	68	60	170		AZP	W	D,E		3	10				BUR
982	84	60	115		AZP	W	D,E		3	10				BUR
983	84	60	170		AZP	W	D,E		3	10				BUR

Ceniceros exterior · Outdoor ashtrays · Cendriers extérieurs



124 +168
pag. 23



124-C
pag. 23



500
pag. 26



424
pag. 24



324

Chapa lisa
Flat plate
Tôle lisse



321

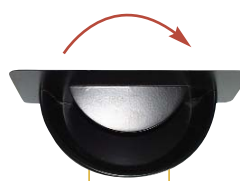

323



421



725



680-CEN



723

REF.	Ø	↑	↔	↘	📄	🔧	📏	🔩	📦	↔	↻	🔗	📦	📦
------	---	---	---	---	---	---	---	---	---	---	---	---	---	---

324	9	41	21		AZP	G	Q	1					400/9	15
321	15	21	23		I	I	Q	2					400/20	15
323	9	26	14		AZP	N	Q	1					400/20	15
421	30	35	35		I	I		2					120/5	12
725	44	4,5			AZP	W	J						160/5	24
680-CEN	38	72	38		AZP	N	H	1,5	5	260	120		120	12
723	25	10,8	8		AZP	N	Q	1,5	5		400/9			12



689 + 716
681 + 716
pag. 17



855
pag. 20



682-A
pag. 20



780-AC
pag. 20



060-070
pag. 21



615
pag. 21



352-AC
pag. 22



717-I
pag. 21



717
pag. 21



731

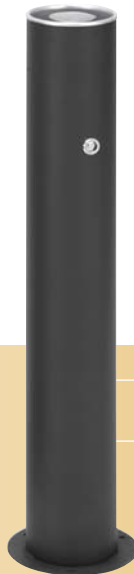

718



719



715



REF	Ø	↑	↔	↘	📄	🔧	📦	🔩	📦	↔	🔄	🔄	📦	📦
718	12	82	17,5		1,56	AZP	X	E		2			80*2	16
719		82	20	20	1,45	AZP	X	E		2			80*2	16
715	7,6	121				AGP	B	D		3			BUR	
731	12	89	17,5			AZP	X	E		2			80*2	16



407



688



606

REF.	Ø	↑	↔	↘	📄	🔑	🗉	🔩	📦	↔	↻	🔗	📦	📦
407	99	44	24	35	AZP	V	E		1				400	15
688	38	82		41	AZP	X	J		1,5				120	15
606	12	120			AZP	X	E		2				BUR	



605



963-A

REF	Ø	↑	↔	↙	📄	🔧	📦	🔩	📦	↔	↻	🔧	📦
605	160	50	38	60	AZP	V	E	1,5	5	160	120*2	6	
963-A	170	52	40	70	AZP	Z	D	1,5	5	100	120*2	6	🔩 🌀



980



982



983



971



5008-B



5008



REF	Ø	↑	↔	↙	📄	🔑	🏠	🔧	📦	↔	↻	🔗	📦	📦
980	68	60	170		AZP	W	D,E			3	10			BUR
982	84	60	115		AZP	W	D,E			3	10			BUR
983	84	60	170		AZP	W	D,E			3	10			BUR
971	78	57	170		AZP	W	D,E	▲						BUR
5008-B / 5008	70	88	200	70	AZP	P	E							BUR



970



5003



5004

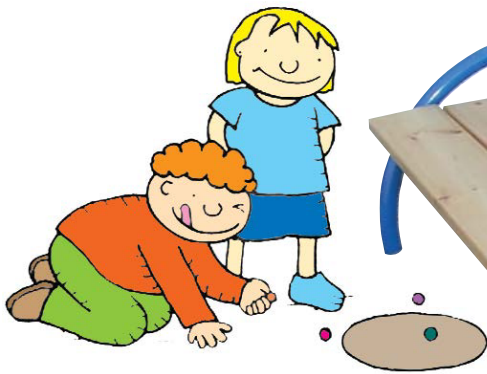

*Diseñado para uso infantil.
No necesita fijación.
Designed for children's use.
Anchorage is not needed.
Dessiné pour usage infantil.
Pas besoin de fixation.*



5009

5010

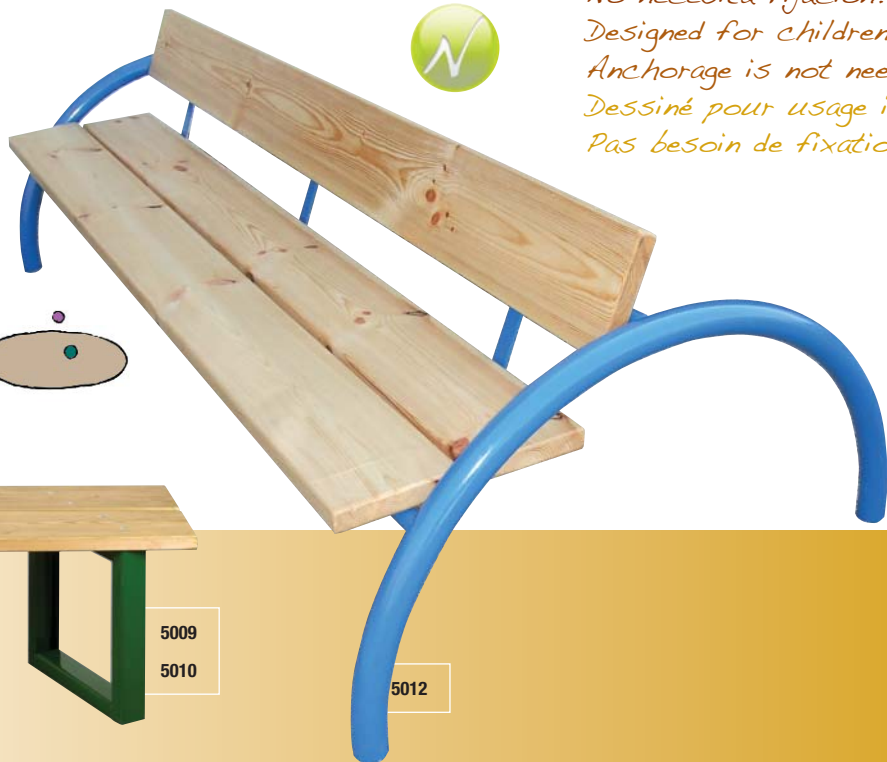

5012



REF	Ø	↑	↔	↘	📄	🔑	📦	🔩	📦	↔	↻	📦	📦
970	58	57	170		AZP	V	D,E	▲					BUR
5003	72	200	61		AZP	N	D	▲					BUR
5004	73	200	74		AZP	N	D	▲					BUR
5009	44	120	37		AZP	V	E	▲					BUR
5010	44	170	37		AZP	V	E	▲					BUR
5012	63	211	100		AZP	N	T	▲					BUR

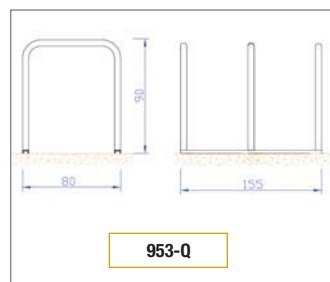
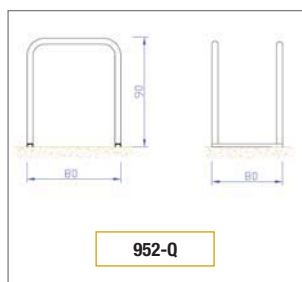
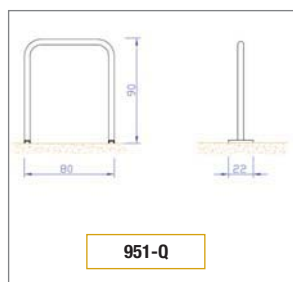
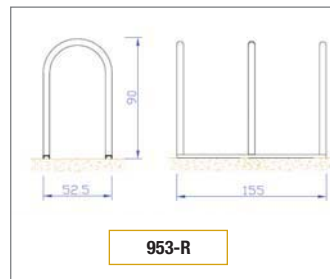
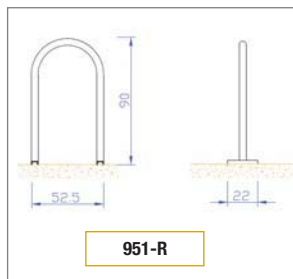

955-3 + 955-2

Set inicial = 3 bicis
Extensión infinita = 2 bicis

Initial set = 3 bikes
Infinite extensions = 2 bikes

Set initiale = 3 vélos
Étendures infinies = 2 vélos



951-R/Q	50			AZP	2
952-R/Q	50			AZP	2
953-R/Q	50			AZP	2
954-R/Q	50			AZP	2
955-3		78,6		AG	
955-2		73,4		AG	
956	23	45	30	AZP	



077



078



079

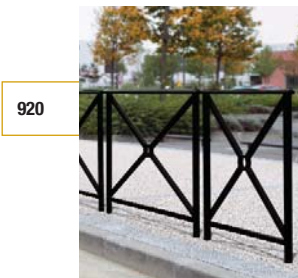

920



930



951-R
951-RP

REF	Ø	↑	↔	↙	📄	🔩	📏	🔩
077	6	100				AZP	N	D
078	10	100				AZP	X	D
079	7,6	100				AZP	N	D
920		123	100			AZP	N	D
930	6	100	150			AZP	N	D
951-R/RP		60	52	5		AZP	W	D/E



1300



941-RI



941-QI

Diferentes tamaños según longitud de visión.
Different sizes according to vision length.
Différentes tailles selon la longueur de vision.



941-RE



941-QE



Limpeza urbana · Urban cleaning · Propreté urbaine

Carros · Cleaning Carts · Chariots

Todos se pueden equipar con ruedas neumáticas
 All of them can be equipped with pneumatic wheels
 Tous peuvent être équipés de pneus



N *Nuevo cubo reforzado
 New reinforced bin
 Nouvelle poubelle renforcée*

REF.	Ø	↑	↔	↙	📄	🔑	🗄️	🔧	📦	↔	🔄	🔗	📦	📦
------	---	---	---	---	---	---	----	---	---	---	---	---	---	---

1096	93	95	58	120-2	AZP	J	R						BUR	4
1095	96	110	67	95-2	AZP	J	R						BUR	



*Nuevo cubo reforzado
New reinforced bin
Nouvelle poubelle renforcée*

REF.	∅	↑	→	↙	📄	🔑	📦	🔩	📦	↔	↻	🔗	📦	📦
131	92	52	67	120	AZP	J	R						120B	4 ☉
135	89	43	50	120	AZP	J	R						120B	4 ☉
132	123	50	68	95	AZP	J	R						120B	6

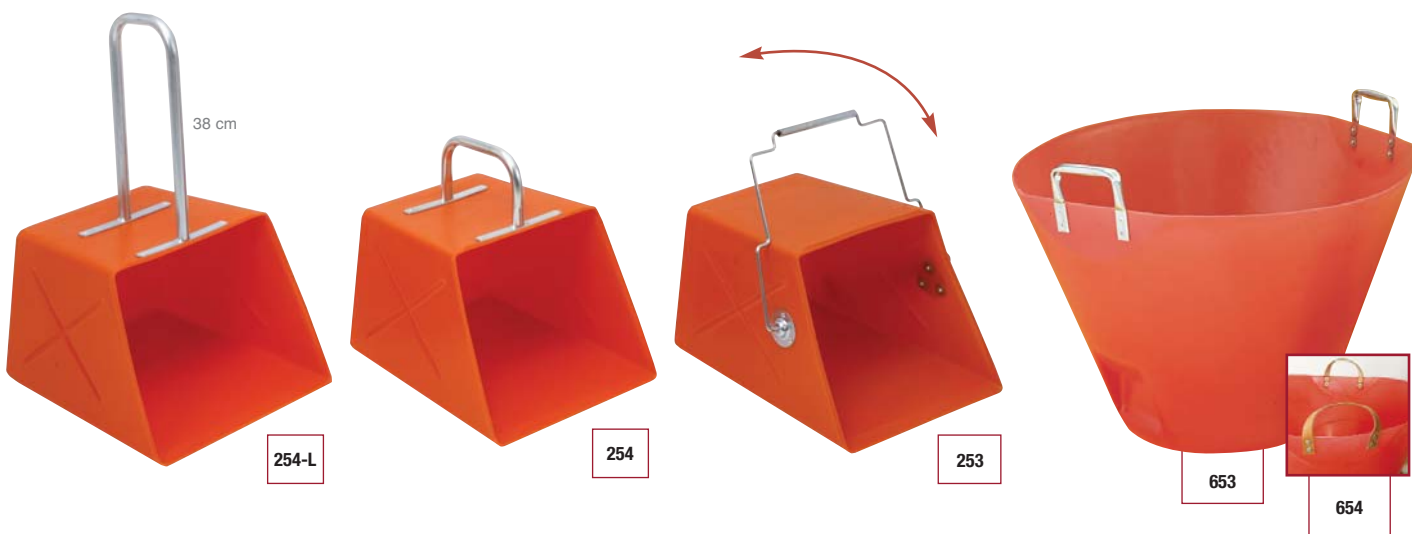

REF	Ø	↑	↔	↘	☰	🔩	📦	🔗	🔄	🔗	📦	📦
253	26	42	35	25	PT	J-A					120/5	12
254	26	42	35	25	PT	J-A					120/3	12
254-L	64	42	35	25	PT	J-A					120/2	12
653/654	70	46		100	PT	J					BUR/10	40

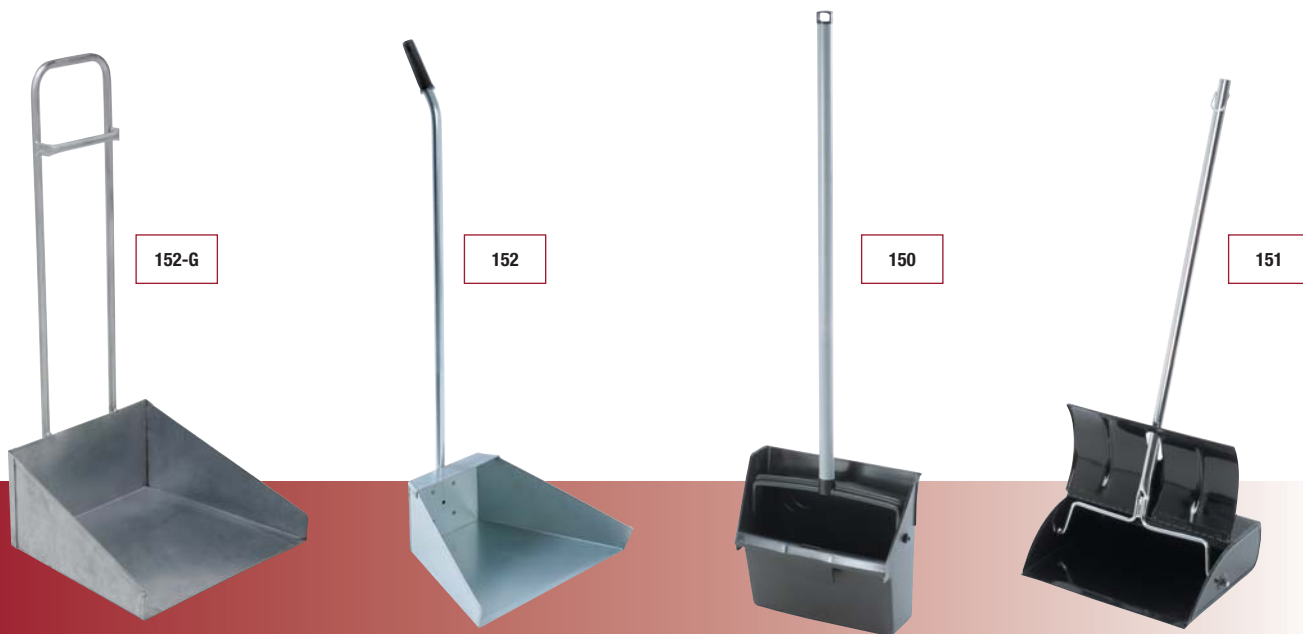

REF	Ø	↑	↔	↘	☰	🔩	📦	🔗	🔄	🔗	📦	📦
152-G	80	39	34		AZ	P					120/2	
152	79	33,5	25		AC	P					12	
150	92	30,5	28		PT	N					6	
151	79	34	24		AP	N					6	

Ergonómica, ligera, larga duración
Ergonomic, light, long life
Ergonomique, léger, longue vie

REF	Ø	↑	↔
021-35	25	158	35
022-35	25	158	35
031	25	135	40
032	25	135	40



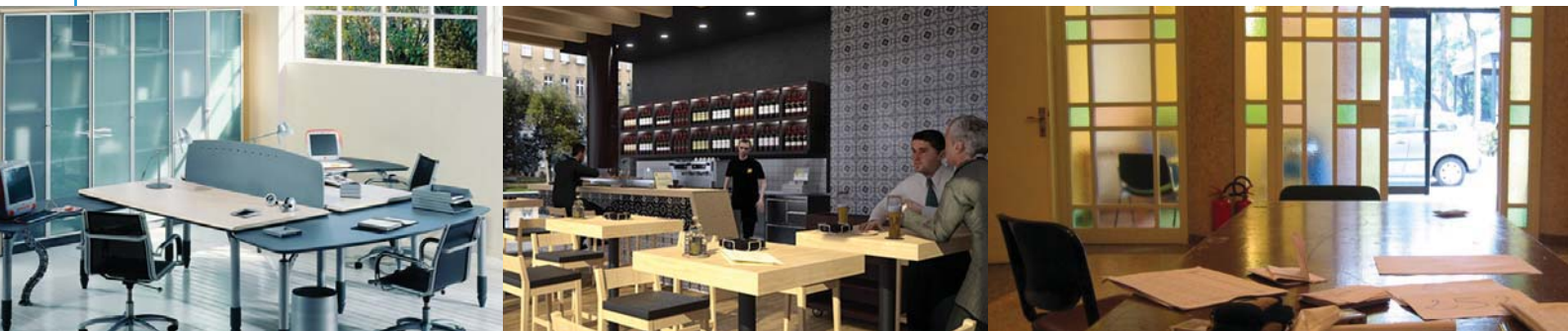

Soportes de saco y papeleras interior

Bag holders and indoor waste baskets

Supports de sacs et de corbeilles à papier intérieur

Soportes de saco · Bag holders · Supports de sacs



847
847-I
147
147-I

837
827
137
127

137-I
127-I



REF	Ø	↑	→	↘	📄	🔑	📦	🔧	📦	↔	🔄	📦	📦		
847	90	38	40	80	AP	B	R					120	12	🌀	🌀
847-I	90	38	40	80	I	I	R					120	12	🌀	🌀
147	90	42	52	120	AP	B	R					160	8	🌀	🌀
147-I	90	42	52	120	I	I	R					160	8	🌀	🌀
127	90	42	48	120	AP	B	R					120	12	🌀	
127-I	90	42	48	120	I	I	R					120	12	🌀	
137	90	42	52	120	AP	B	R					160	8	🌀	🌀
137-I	90	42	52	120	I	I	R					160	8	🌀	🌀
837	90	37	42	80	AP	B	R					120	12	🌀	🌀
837-I	90	37	42	80	I	I	R					120	12	🌀	🌀
827	90	37	38	80	AP	B	R					80	16	🌀	
827-I	90	37	38	80	I	I	R					80	16	🌀	



REF	Ø	↑	→	↙	📄	🗑️	📦	🔧	📦	↔️	🔄	🔗	📦	📦	
800	84	37	30	80	AP	B	R,T						80	16	⊙
800-I	84	37	30	80	I	I	R,T						80	16	⊙
800-P	84	37	35	80	AP	B	R,T						120	12	⊙ ⊖
800-PI	84	37	25	80	I	I	R,T						120	12	⊙ ⊖
120	84	42	34	120	AP	B	R,T						120	12	⊙
120-I	84	42	37	120	I	I	R,T						120	12	⊙
120-P	84	42	46	120	AP	B	R,T						160	8	⊙ ⊖
120-PI	84	42	46	120	I	I	R,T						160	8	⊙ ⊖
160	84	49	42	160	AP	B	R,T						160	8	⊙
120-PX	84	42	46	120	AP	B	R,T						160	8	⊙ ⊖



121
121-I
801
801-I



121-L



121-LB



129 / 129-I



CLICK !!!



128

REF. Ø ↑ ↔ ↘ E 🔑 📏 🔧 📦 ⇄ ⇄ ⇄ ⇄ ⇄ ⇄ ⇄ ⇄ ⇄ ⇄

121	21	42	37	120	AP	B	Q	120/6	12	⊙
121-I	21	42	37	120	AP	I	Q	120/6	12	⊙
801	21	37	32	80	AP	B	Q	80/6	18	⊙
801-I	21	37	32	80	AP	I	Q	80/6	18	⊙
121-L	100	42	37	120	AZP	B	A	120/2	12	⊙
121-LB	100	42	37	120	AZP	B	E	120/2	12	⊙
129	86	46	40	120	AZ		T	160/2	8	⊙
129-I	86	46	40	120	I		T	160/2	8	⊙
128	40	73		80/120	AZ		T	120/15	12	⊙





REF	Ø	↑	↔	↘	☒	🔧	📦	🔩	📦	↔	↻	📦	📦	
120-02	90	45	34	120	AZP	P	E					120	12	⊙
120-02-I	90	45	34	120	I	I	E					120	12	⊙
2091	83	50	50	200	AZ	P	T					400/5	9	
1291	80	46	31	120	AZ	P	T					400/5	9	
800-P	84	37	35	80	AP	B	R,T					120	12	⊙ ⊖
120-P	84	42	46	120	AP	B	R,T					160	8	⊙ ⊖
340-N/340-NA	62	25	20	30	AP	Z	T					400/2	15	
120-PD	84	86	46	120-2	AP	B	R,T					120*2		⊙ ⊖

251



*Otras medidas y colores por encargo.
Other colours and sizes by order
Autres tailles et couleurs sur commande.*

124-B



Con puerta
With door
Avec porte

120-3



800-3



REF Ø ↑ ↔ ↙ ↘ E 🔧 📏 🔪 📦 → ⇄ ↻ 🔗 📦 📦

251		33	5	25	AP	B	Q			80/10	16	⊙
124-B	145	42	34	120	AP	B	B	1		120	12	⊙ ⊙
120-3	134	42	36	120	AP	B	R,T			120	12	⊙
800-3	99	37	30	80	AP	B	R,T	0,8		80	16	⊙



*Nuevo cubo reforzado
New reinforced bin
Nouvelle poubelle renforcée*



Con puerta / With door / Avec porte

REF	Ø	↑	→	↘	☰	🔑	🔩	📦	↔	🔄	📏	📦	📦
1195-R	51	78				PT	N						BUR
1137	68	86	53			PT	N	R					8
137-RI		90	42	52	120	I	I	R	0,8				160
137-RL/137-R		90	42	52	120	AP	B	R	0,8				160



REF	Ø	↑	↔	↘	☰	🔑	🔑	🔑	🔑	🔑	🔑	🔑	🔑	🔑	🔑
348 / 348-I	50	35	19	30	AZP/I	B/I	H		0,8		80/2	16-2			
348-P	50	35	28	30	AZP	B	H		0,8		120/2	12			
348-PI	50	35	28	30	I	I	H		0,8		120/2	18			
218	32	27	11	10	AZP	V/J	Q		0,8		80/10	16-16			
218-I	32	27	11	10	I	I	Q				80/10	16-16			
258	50	35	19	30	AZP	V/J	Q		0,8		160/5	8-5			
258-I	50	35	19	30	I	I	Q		0,8		160/5	8-5			



REF	Ø	↑	↔	↘	☰	🔑	🔑	🔑	🔑
1030-30	50	41	25	30	PT	AZVRG	H		☉
1030-60	67	50	41	60	PT	AZVRG	H		☉
1055	59	42	32	55	PT	B	H		
1025	51	33	21	25	PT	B	H		
1026	44	32	33	26	PT	B	H		☉ ☉
045	42	20	54	17	PT	B	H		☉



335

REF	Ø	↑	↔	↘	📄	🔑	📦	🔩	📦	↔	↻	🔗	📦	📦
580-P	89	49	49	100	PT	G								
1040	36	79		40	I									
335	35	77		62	I	I	H			1				



580

570



013-I
014-I
030-I



013
014
030

REF	Ø	↑	↔	↘	📄	🔑	📦	🔩	📦	↔	↻	🔗	📦	📦
570	68	31	25	35	AZP	B	H			1			330	45
580	104	50	40	200	AZP	B	H			1			160	8
013	21	28		5	AZP	B	H						80/4	16
013-I	21	28		5	I	I	H						80/4	16
014	25	40		14	AZP	B	H							
014-I		25	40		14	I	I	H						
030	30	61		30	AZP	B	H							
030-I	30	61		30	I	I	H							



REF	Ø	↑	↔	↘	📄	🔑	🗄	🔩	📦	↔	↻	🔗	📦	📦
460	42	87			70	AZP	B	H	1				160	8
319	25	66			20	AZP	B	H	0,8				120B/6	4
300	21	66			15	AZP	B	H	0,8				160/4	8
461		87	41	22	35	AZP	B	H	1				400	15
361		75	36	19	25	AZP	B	H	0,8				400	15



REF	Ø	↑	↔	↘	📄	🔑	🗄	🔩	📦	↔	↻	🔗	📦	📦
292		91	50	37		AL	P	H						



REF	Ø	↑	↔	↘	📄	🔧	📏	🔑
320	68	30	19	30	AP	B	H	
315	66	18	18	15	AP	B	H	
325 / 325-I	70	25	25		AP / I	P	H	
330	55	32	32	35	AP	B	H	⊙



- 4200 Ø 20 cm
- 4250 Ø 25 cm
- 4360 Ø 335 cm
- 4460 Ø 45 cm



REF	Ø	↑	↔	↘	📄	🔧	📏	🔑	📏	📏	📏
101	25	32			AP	B	H				
101-PI	21	32			I	I	H				
290	21	50			AP	B	H				
290-PI	21	50			I	I	H				
110 / 110-I	21	66		20	AP/I	B/I	H		330	45	
118 / 138-I	7	13	8		AZP/I	B/N/I	Q		80*50	16	
138 / 138-I	12	27	12		AZP/I	B/N/I	Q		80*20	16	
158 / 158-I	19	27	12		AZP/I	B/N/I	Q		80*10	16	



REF	∅	↑	↔	↘	📄	🔑	📦	🔩	📦	↔	↻	🔗	📦	📦
237/241	122	104	51		ACR/I									
225	104	108	70		ACR									
240	104	147	51		I									
242	104	119	51		ACR									



REF	∅	↑	↔	↘	📄	🔑	📦	🔩	📦	↔	↻	🔗	📦	📦
247	110	132	75		PT									



236



245



246



236	87	72	50	ACR	R
245	98	113	50	PT	G R
246	96	102	50	PT	



221



522-55
522-75



007

006

090

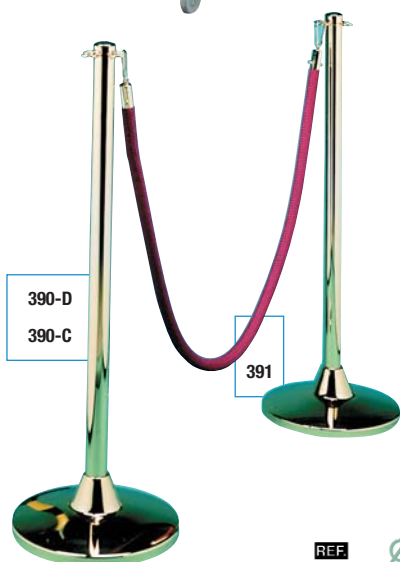

390-D
390-C

391



521



080

45 cm

010

45 cm

082

100 cm

012

100 cm



390-D/C/I	35	88			AD/ACR/I	H	1,5	80*8	16
221	62	48	39	25	PT	Z	R		
522-55		55			AZ				
522-75		75			AZ				



Accesorios baño Bath accessories Accessoires de bain

Dispensadores de jabón · Soap dispensers · Doseur de savon



Antivandálico
Posibilidad de montaje en serie
Tubo interior inox

Cuerpo de latón cromado o dorado
Combina con todas las griferías

Versatilidad de instalación con extensa gama de accesorios
No gotea

Instalables en superficies entre 2 y 60 mm
Opción relleno superior

Anti-vandalism
Possibility of mass-production assembly
Internal stainless

Steel tube
Body in chrome or gold brass
It matches with all taps

Versatility of installation with a wide range of accessories
Non-dripping.

Mountable on surfaces between 2 and 60 mm
Top filling option

Antivandalisme
Possibilité de montage en série
Tuyau intérieur inox

Corps en laiton chromé ou doré
Combine avec toutes les robinetteries

Versatilité d'installation avec vaste gamme d'accessoires
Ne goutte pas

Possible à installer en surfaces entre 2 y 60 mm
Option remplissage supérieur

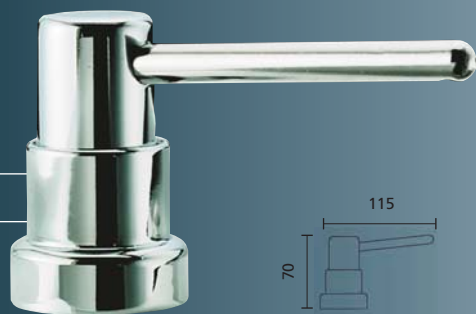

Boquilla desmontable para rellenar por la parte superior.
Two piece nozzle for filling up through the top part.
Traverse démontable pour remplir par la partie supérieure.



Ref. 660 1L / 660 B 0,5 L



Ref. 661



Ref. 662 1L / 662 B 0,5L

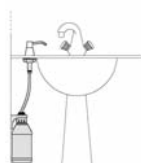

Ref. 663 1L / 663 B 0,5L



Ref. 664

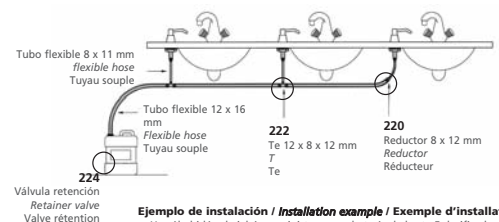

Ejemplo de instalación / Installation example / Exemple d'installation
 Un sólo bidón de jabón suministra a una batería de hasta 5 dosificadores.
 Only one bottle of soap can supply a battery of up to 5 measuring devices.
 Un seul bidon de savon alimente une batterie de 5 doseurs.

279
0,8 L.



270
1 L.



276
1 L.



273 1,5 L.



275 3 L.

Especial pasta
Suitable for paste
Spécial pâte



278
0,9 L.



554
0,8 L.



Dosificador de jabón en espuma
Foam soap dispenser
Doseur de savon en mousse

Perchas · Hangers · Cintres

291
Ø 30 x 180 cm



3001

Ø 8x7,5x14 cm



3404

56x28x16 cm
Inoxidable
Stainless steel
Inoxydable

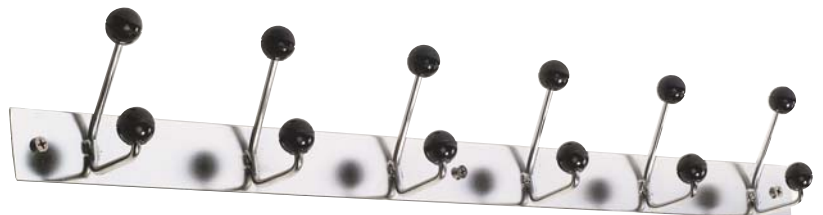

- | | | |
|-------------|--|------------------|
| 3002 | 2 doble percha / 2 double hanger / 2 double cintre | Ø 11 x 7 x 26 cm |
| 3003 | 3 doble percha / 3 double hanger / 3 double cintre | Ø 11 x 7 x 39 cm |
| 3004 | 4 doble percha / 4 double hanger / 4 double cintre | Ø 11 x 7 x 52 cm |
| 3005 | 5 doble percha / 5 double hanger / 5 double cintre | Ø 11 x 7 x 65 cm |
| 3006 | 6 doble percha / 6 double hanger / 6 double cintre | Ø 11 x 7 x 78 cm |

Inoxidable con bolas de baquelita
Stainless steel with bakelite balls
Inoxydable avec billes en bakelite



3503-I
80 cm.



3505-I
60 cm.



3507-I
30 cm.



3511-I
70 x 70 cm.



3405
90 x 10 x 8 cm.



3500-I
51 cm.
46 x 41,5 cm.



3509-PI
80 x 80 cm.



3509-I
84 cm.

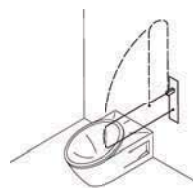

I = Inoxidable mate / rough stainless steel / inoxydable terne

Portarrollos papel higiénico · Toilet paper roll-holder · Porte-rouleaux papier hygiénique



207 Ø 26
207-2 Ø 22

Chapa galvanizada pintada
Painted galvanized plate
Plaque galvanisée peinte



207-1 Ø 26
207-12 Ø 22

Inoxidable
Stainless steel
Inoxydable



207-P Ø 26
207-P2 Ø 22

Plástico
Plastic
Plastique



208-P
14 x 14 x 29 cm
Plástico
Plastic
Plastique



208
11,5 x 11 x 35 cm.
3 rollos. Inoxidable.
3 rolls. Stainless steel.
3 rouleaux. Inoxydable.



209
11,5 x 11 x 39,5 cm.
3 rollos. Inoxidable. Empotrable
3 rolls. Stainless steel. Built-in unit
3 rouleaux. Inoxydable. Pour enchâsser

Portarrollos papel manos · Hand paper roll-holder · Porte-rouleaux essuie-mains



103
27,5 x 12 x 36,5 cm. ABS
Plástico / *Plastic* / Plastique

104
25 x 12,5 x 33 cm. Metálico.



104-I
25 x 12,5 x 33 cm.
Inoxidable
Stainless steel
Inoxydable



Ref. 641-N
34 x 23 x 24 cm.



643
14 x 14 x 29 cm.
Plástico / *Plastic* / Plastique



642
30 x 27 x 23 cm.
Chapa galvanizada
Galvanized plate
Plaque galvanisée



307
44 x 48 x 78 cm.
De pie. *Standing*
Sierra inoxidable.
Stainless steel saw
Scie inoxydable

307-I
Inoxidable.
Stainless steel
Inoxydable

309
42 x 41 x 52 cm.
Mural o sobremesa.
Wall or desktop
Mural ou table
Sierra inoxidable.
Stainless steel saw
Scie inoxydable

309-I
Inoxidable
Stainless steel
Inoxydable



3401
 Ø 8 x 11,5 cm.
 Acepta cualquier diámetro de rollo de papel
 Any diameter of paper roll is accepted
 Accepte tout diamètre de rouleau de papier



3402
 28,5 x 10 x 8 cm.



3403
 12 x 8 x 27 cm.



3405
 90 x 10 x 8 cm.



124-B



120-3



800-3

REF	Ø	↑	→	↘	📄	🔑	📦	🔧	📦	↔	↻	📏	📦	
124-B	145	42	34	120	AP	N	B		1				120	12
120-3	134	42	36	120	AP	B	R,T						120	12
800-3	99	37	30	80	AP	B	R,T						80	16



6300
22,5 x 16 x 30 cm. 2000 W.
Célula fotoeléctrica
Photoelectric cell
Cellule photoélectrique



6400
22,5 x 16 x 30 cm. 2000 W.
Con pulsador
With pushbutton
Avec pulseur



6100
28,3 x 22,5 x 22,2 cm. 2400 W.
Célula fotoeléctrica
Photoelectric cell
Cellule photoélectrique



6200
28,3 x 22,5 x 22,2 cm. 2400 W.
Con pulsador
With pushbutton
Avec pulseur



6100-P
26,5 x 24 x 17 cm. 2200 W.
Célula fotoeléctrica
Photoelectric cell
Cellule photoélectrique



6300-P
24 x 24 x 23 cm. 1800 W.
Célula fotoeléctrica
Photoelectric cell
Cellule photoélectrique



6600 1200 W.



6500
21,5 x 10 x 57 cm. 800 W.



7008
18 x 18 x 30 cm. 13 w.
Elimina insectos especial para exterior
Kills insects. Special for outdoors
Élimine insectes spécial pour extérieur



7000
45 x 15,5 x 15 cm
Con banda adhesiva sin explosión
With adhesive band. Non explosive
Avec bande adhésive sans explosion



- 750** Difusor de perfume. 7,5 x 15 x 3 cm. Autónomo, funciona con 2 pilas de 9V. durante un año. Pueden programarse las pulverizaciones a 3 niveles. Puede funcionar 24 h. al día o sólo cuando la estancia está alumbrada.
- 751** HERMANO, Bergamota para oficinas.
- 752** NOTE VERDE, Bosque y jacinto refrescantes.
- 756** ANTI-TABACO, Mentol y clorofila, elimina el olor a tabaco.
- 757** INSECTICIDA, Elimina insectos con aroma a lavanda.
- 759** STROMBOLI, Potente aerosol que perfuma hasta 80m³ durante varias horas con una sola pulverización. Con aroma a eucalipto.



PAPEL HIGIENICO NORMAL
NORMAL TOILET PAPER

096

21 m / 2 capas
112 und - caja

097

56 m / 2 capas
60 und - caja

(para portarrollos ref. 208)



**PAPEL HIGIENICO INDUS-
TRIAL**
INDUSTRIAL TOILET PAPER

105

95 mm / 150 m / 2 capas
eje 45 mm / 18 und - caja

107

95 mm / 300 m / 1 capa
eje 45 mm / 12 und - caja
(para portarrollos ref. 207 y 207-I)



TOALLITAS DE CELULOSA
CELLULOSE TOWELETTES

205

4800 (24 x 200) und - caja

206

Tissue
4000 und - caja

(* para toallero ref. 104 y 103)



BOBINAS INDUSTRIALES DE CELULOSA
INDUSTRIAL CELLULOSE REELS

301

250 mm x 1000 m
1 capa / 2 und- caja

302

250 mm x 500 m
2 und-caja / 2 capas

(para portarrollos ref. 307 y 309)



BOBINAS SECAMANOS DE CELULOSA
CELLULOSE HAND DRIER REELS

631

230 mm x 330 m
1 capa / 6 und- caja

632

ø 200 x 230 mm x 160 m
2 capa / 6 und- caja

633

230 mm x 150 m
2 capas / gofrado
6 und- caja

634

ø 130 x 200 mm x 120 m
1 capa / 12 und- caja

(para portarrollos ref. 640)



BOBINA AUTOMATICA DE CELULOSA
CELLULOSE AUTOMATIC REEL

635

120 mm x 70 m
1 capa / 12 und- caja



BOBINAS CAMILLA DE CELULOSA
CELLULOSE REELS FOR STRETCHERS

636

590 mm x 70 m
1 capa / 6 und- caja
precorte



116*

REF.	Ø	↔	↑	📄	🔑	📦	🔑	📦	↔	↻	🔗	📦	📦
99		12	25	1		B			170				1000
101		40	60	25		B			150				500
305		20	30	2		N			100				6000
310		19	35	2		N			100				5000
311		25	30			TTE							15000
102		41	87	30		B			200				400
42x72		42	72	30		TTE			100				1200
140		52	60	32		ZAVM			100				1200
105		54	65	35		B			200				400
106		54	100	80		ARV			180				400
106		54	100	80		Z			200				300
107		54	100	80		B			300				250
108		54	100	80		B			400				200
112		65	110	120		N			180				300
109		65	10	120		Z			200				300
113		65	110	120		ARV			250				250
110		65	110	120		B			300				250
111		65	110	120		B			400				175
165		80	110	170		N			180				300
166		80	110	170		TTE			180				250
162		80	110	170		Z			200				250
163		80	110	170		Z			300				200
164		90	110	200		Z			200				200
168		90	110	175		Z			300				200
120x135		120	135	240		N			120				120
116*		65	110	120					x2				100

